

1. Features



- Unique split design makes it suitable to be built in lighting fixtures which have limited space.
- Work with 0-10V dimmable LED drivers, easy to achieve dimming function.
- Adjustable detecting sensitivity, hold time, stand-by/on-off via DIP switches, suitable to a variety of installation sites.

2. Parameter

Input	Operating Voltage Range	108-305V AC, 50Hz/60Hz
	DC Input Voltage	N/A
	Rated Voltage	120-277V AC, 50Hz/60Hz
	No-load Power	N/A
	Stand-by Power	≤0.5W
	Surge Test	L-N: 1kV
Output	Working Mode	ON/OFF function, 1-10V dimming
	Type of Load	Inductive or Resistive Load
	Load Capacity	120Vac: 3.6A; 270Vac: 3.4A
	Current of Load	N/A
	Max. Surge Capacity	30A (50% I _{peak} , t _{width} =500uS, 230Vac full load, cold start); 60A (50% I _{peak} , t _{width} =200uS, 230Vac, full load, cold start)
Dim Interface	1-10V Dimming	Yes.
	Synchronous Control	N/A
	High Low-level	N/A
	PWM Control	N/A
Sensor Parameters	Operating Frequency	5.8 GHz ±75 MHz , ISM Band.
	Transmitting power	0.5mW Max.
	Hold time	5S/1min/5min/10min/15min/30min
	Stand-by DIM Level	10%/20%/30%/50% (set via 2 DIP Switch)
	Stand-by Period	0S/10S/1min/10min/30min/1h/∞
	Detection Sensitivity	100%/75%/50%/25% (set via 2 DIP Switch)
	Daylight Sensor	5lux/15lux/30lux/50lux/100lux/150lux/Disable (set via 4 DIP Switch) (Ambient light diffusion)
	Daylight on/off	N/A

	Detecting Radius	4-6m (mounting height 3m)
	Mounting Height	6m Max
	Detecting Angle	150°
Wireless Module	Operating Frequency	N/A
	Transmitting power	N/A
	Transmitting distance	N/A
	Modulation mode	N/A
	Number of coding	N/A
Operating Environment	Operating Temperature	-35~+70°C
	Storage Temperature	Temperature: -40°C...+80°C; Humidity: 10%-95% (Non-condensing)
Certificate Standards	Safety standards	UL60730-1, AS/NZS 60669.2.1
	EMC standards	FCC part 15
	Environmental Requirement	Compliant to RoHS
	Certificate	UL Reconized, SAA
Others	Wiring	Press-in Type Terminals, wire diameter : 0.75-1.5mm ²
	IP Rating	IP20
	Protection Class	Class II
	Installation	Built-in
	Dimension	Main Part: 95*42.5*26mm Sensor Head: 51*20*13.5mm
	Package	Bubble bags + clapboard +carton (K=A)
	Net Weight	94.2g
	Lifetime	50,000h @ Ta Full load

Note

1. "N/A" means not available.
2. Detection area is affected on volume of motion object and motion speed. The detection area is tested by a 165cm height person and walking speed is 0.5m/s.

3. Function

1) On/OFF Function

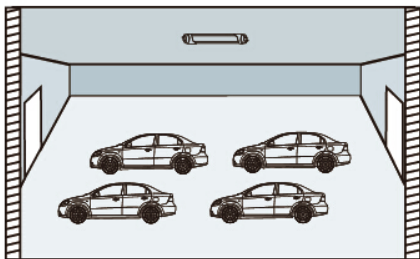

1 With sufficient ambient light, the light will not be switched on even if with motion signal.

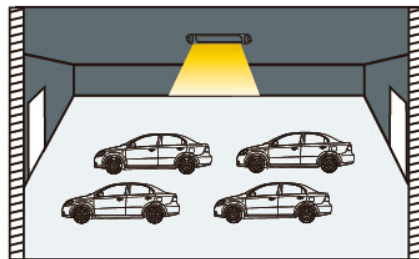

2 With insufficient ambient light, the sensor switches on the light when motion is detected.



3 After elapse of hold time, the sensor switches off the light when no motion is detected.

2) 2- step dimming function (stand-by period set at “+∞”)

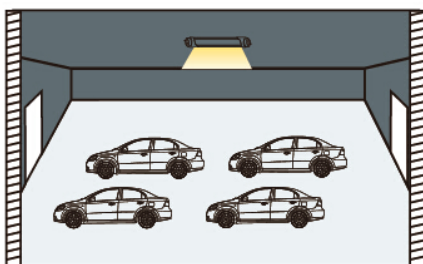

1 If there is no motion detected, the light will be remained at a low light level all the time.

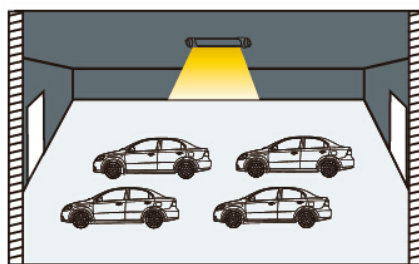

2 When motion is detected, the sensor will switch on the light to 100% brightness

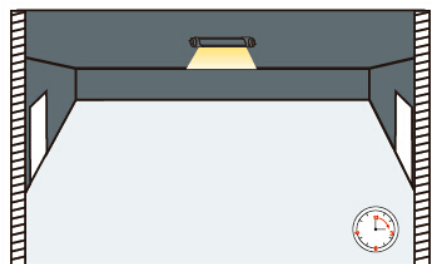

3 After elapse of hold time, the sensor dims the light at the present low light level if no motion is detected.

3) 3-step dimming function (stand-by period set at “5min/10min/30min/1h”)

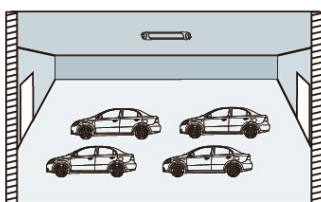

1 With sufficient ambient light, the light will not be switched on even if with motion signal.

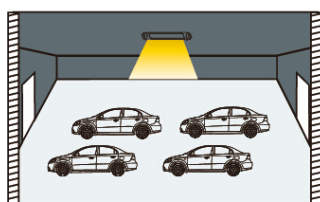

2 With insufficient ambient light, the sensor switches on the light when motion is detected.

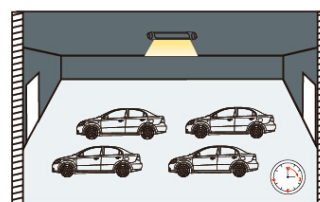

3 After elapse of hold time, the sensor dims the light at a low light level if no new motion is detected.



4 After elapse of standby period, the sensor switches off the light if no motion is detected in the detection zone.

4. Dimension (mm)

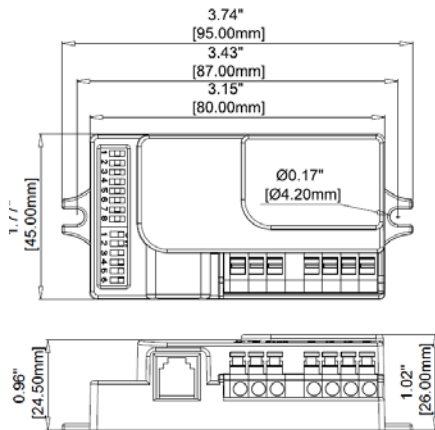

Main Part Size

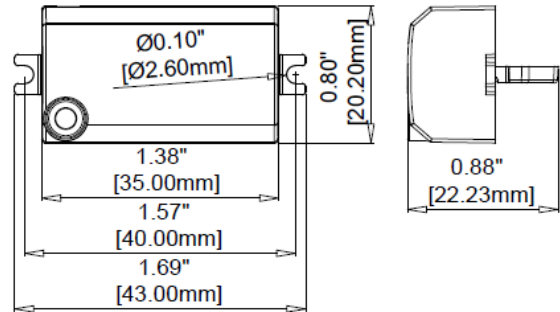

Sensor Head Size

5. Wiring

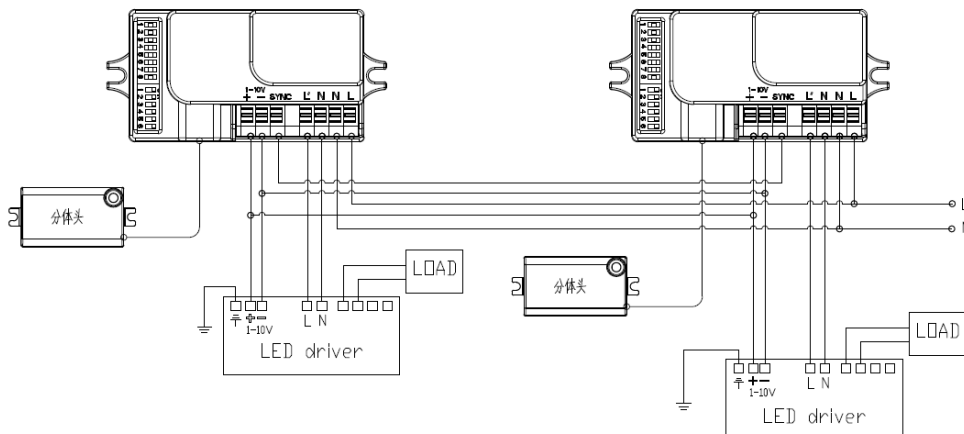

*The sensor is designed for connect one load only. Connect more than one loads may damage the sensor.

6. Structure

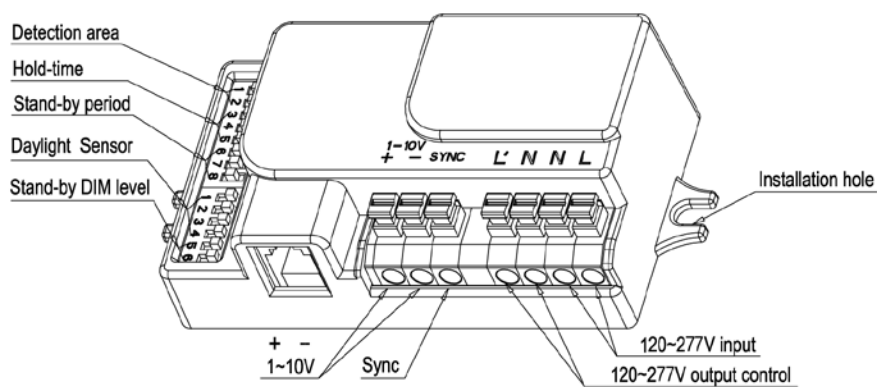

7. Radiation Pattern

Ceiling mounting

Ceiling mounted height: 3m
Sensitivity: 100%/75%/50%/25%

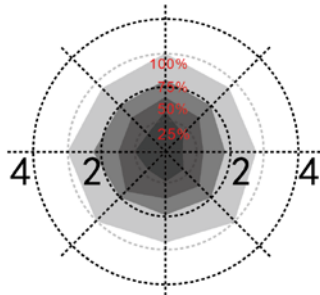

Normal moving (Speed:1m/s)

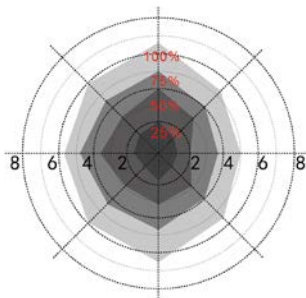

Slow moving (Speed 0.3m/s)

Ceiling mounted height: 6m(*)
Sensitivity:100%/75%/50%

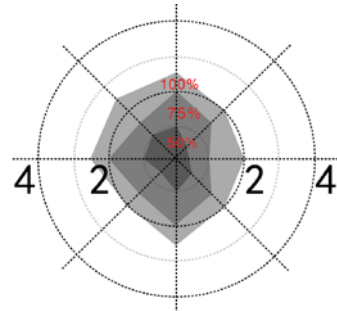

Normal moving (Speed:1m/s)

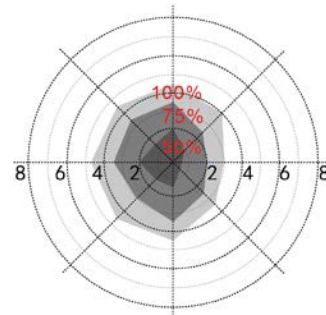

Slow moving (Speed: 0.3m/s)

* 50%, 75%, 100% detection sensitivity is workable when installed at 4m mounting height. Only 25% sensitivity is not able to detect motion signal.

Wall mounting:

Horizon mounted height: 2m
Sensitivity: 100%/75%/50%/25%

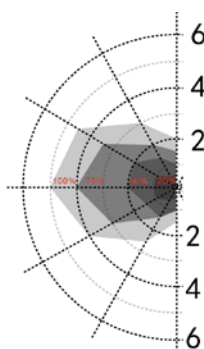

Normal moving (Speed: 1m/s)

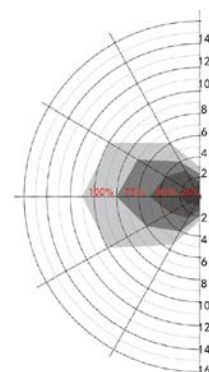

Slow moving (Speed 0.3m/s)

8. DIP Switch Setting

Detection Area (Sensitivity)

	1	2	
I	ON	ON	100%
II	ON	-	75%
III	-	ON	50%
IV	-	-	25%

Hold Time

	3	4	5	
I	ON	ON	ON	5S
II	-	ON	ON	30S
III	ON	-	ON	1min
IV	-	-	ON	5min
V	ON	ON	-	10min
VI	-	ON	-	20min
VII	-	-	-	30min

Stand-by Period

	6	7	8	
I	ON	ON	ON	0S
II	-	ON	ON	10s
III	ON	-	ON	1min
IV	-	-	ON	10min
V	ON	ON	-	30min
VI	-	ON	-	1h
VII	-	-	-	+∞

Stand-by dim Level

	1	2	
I	ON	ON	50%
II	-	ON	30%
III	ON	-	20%
IV	-	-	10%

Daylight Sensor

	3	4	5	6	
I	ON	ON	ON	ON	5Lux
II	-	ON	ON	ON	15Lux
III	ON	-	ON	ON	30Lux
IV	-	-	ON	ON	50Lux
V	ON	ON	-	ON	100Lux
VI	ON	ON	ON	-	150Lux
VII	-	-	-	-	Disable*

*Disable means the daylight sensor does not work. The sensor will turn on the light once motion is detected regardless of ambient light level.

9. Initialization

1/ On/Off function /3-step dimming function:

After power on, the sensor automatically turns on light at 100% brightness. After 10sec, it turns off the light. During the initialization, the sensor is not able to detect movement.

2/ 2-step dimming function:

After power on, the sensor automatically turns on light at 100% brightness. After 10sec, it dims the light to a low light level (set by stand-by dim level). During the initialization, the sensor is not able to detect movement.

10. Factory Setting

Detection Area: 100%, Hold Time: 10 mins, Stand-by Period: Infinity, Stand-by dim Level: 30%, Daylight Sensor: Disable

11. Application Notice

Be sure to power off before adjusting DIP switch setting.

12. Version Change

Version	Date	Description
A0	July 27, 2016	Released new product
A1	March 20, 2018	Change the sensor head size